

**Dimensiuni reper (mm)**

- |   |                                  |   |
|---|----------------------------------|---|
| <b>1 Laterală ST/DR</b> 1904x459 (2 buc.) | <b>3 Tavan</b> 1644x480 (1 buc.) | <b>5 Intermediară</b> 1828x459 (1 buc.) |
| <b>2 Uși</b> 1840x406 (4 buc.)            | <b>4 Bază</b> 1608x459 (1 buc.)  | <b>6 Poliță fixă</b> 796x384 (4 buc.)   |
| <b>7 Plintă</b> 1608x60 (1 buc.)          |                                  |   |

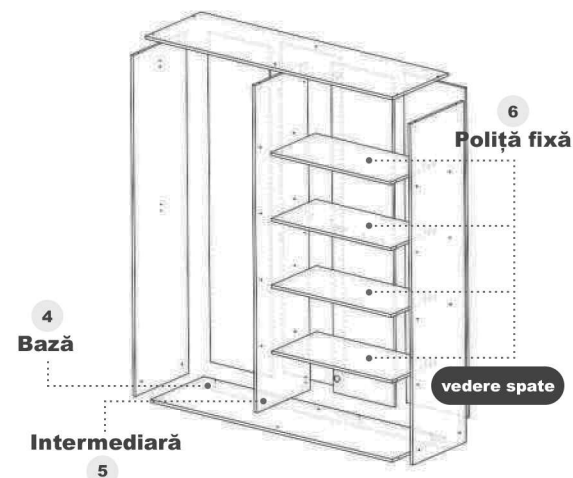
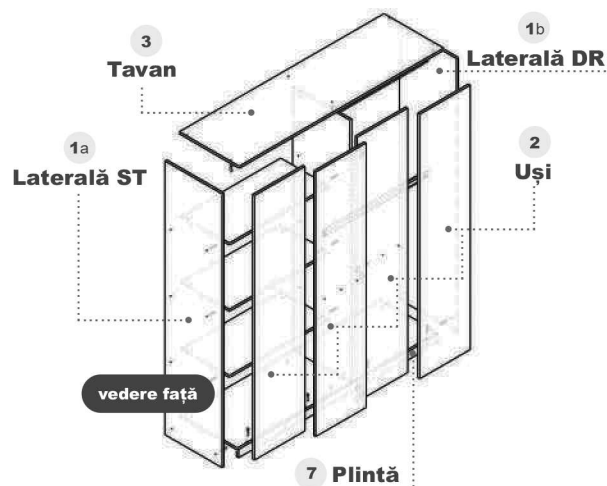
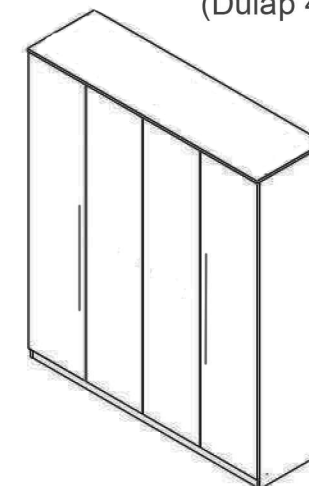
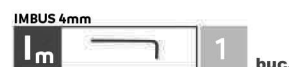
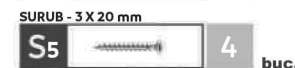
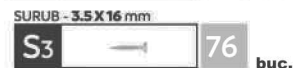
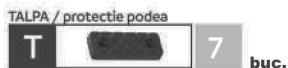

**Unelte necesare montajului:**

ATENȚIE: MONTAJUL NECORESPUNZĂTOR ATRAGE DUPĂ SINE PIERDEREA GARANȚIEI PRODUSULUI



Șurubelniță în cruce sau autofiletantă



Este **recomandat** ca montajul să fie făcut de **minim două persoane**



Un **ciocan** de dimensiune medie



**Echipamentul de protecție** aferent uneltelor pe care le folosiți

# Instrucțiuni montaj:

## Dormitor DOUGLAS Dulap 4U

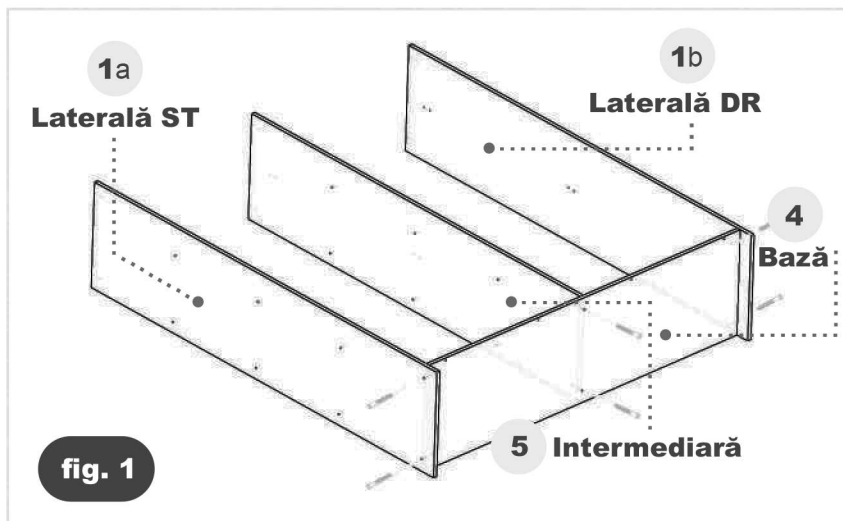

- 1 Se prinde **baza(4)** de **laterale ST(1a) / DR(1b)** și **intermediara(5)** cu **6 confirmatoare C5**
- 2 Se prinde **plinta(7)** cu **4 confirmatoare C5**
- 3 Se prinde **tavanul(3)** de **laterale ST(1a) / DR(1b)** și **intermediara(5)** cu **6 confirmatoare C5**
- 4 Se prind suportii bara haine de **laterala DR(1b)** și **intermediara(5)** cu **4 șuruburi S3**
- 5 Se prinde **talpa alunecătoare (6xT)** de **laterale ST(1a) / DR(1b)** și **plintă(7)** cu **12 șuruburi S3**
- 6 Se prind **polițele fixe(6)** de **laterala ST(1a)** și **intermediara(5)** cu **16 confirmatoare C5**
- 7 Se aduce corpul în vîlcu la 90 Grade și se prinde **spatele (HDF)** cu **76 de cuie**
- 8 Se prind **balamalele aplicate (Ba)** de **laterala ST(1a) / DR(1b)** și **uși(2)** cu **24 șuruburi S3** și **balamalele semiaplicate (Bs)** de **intermediara(5)** și **uși(2)** cu **24 șuruburi S3**
- 9 Se prinde **bucsa opritoare (R1)** de **tavan(3)** cu **4 șuruburi S5**
- 10 Se prind **manerele (Mx2)** de **uși(2)** cu **6 șuruburi S4**

