

Instructiuni montaj: **Corp Inferior 600 mm**

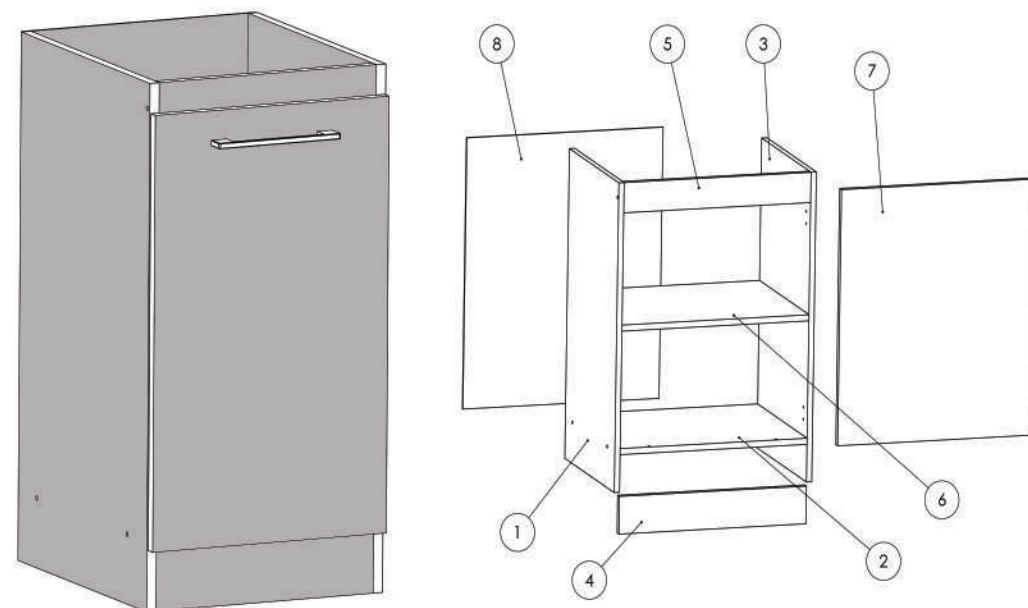

NR. REPER	DETALII	COD REPER	CANTITATE
1	820X456X16	LATERALA ST	1
2	466X456X16	FUND	1
3	820X456X16	LATERALA DR	1
4	466X100X16	SOCLU	1
5	466X80X16	LEZENA SUPERIOARA	1
6	466X456X16	POLITA MOBILA	1
7	494X678X16	USA ST.DR	1
8	494X718X4	HDF	1

ATENȚIE: MONTAJUL NECORESPUNZĂTOR ATRAGE DUPĂ SINE PIERDEREA GARANȚIEI PRODUSULUI



Șurubelniță în cruce
sau autofiletantă













Este **recomandat** ca
montajul să fie făcut de
minim două persoane



Un **ciocan** de dimensiune
medie

Elemente feronerie:

CONFIRMATOR 50mm C  8	SURUB TIP CONFIRMATOR 4x27 S4  2	SURUB 3.5X30 S6  4	MANER UR 160 M  1
SURUB 3.5X16 S3  24	SUPPORT POLITA Sp  4	BALAMALE APLICATE Ba  2	
CUIE Cu  17	COLTAR 40X40 Co  2	TALPA ALUNECATOARE Ta  4	

Pasul 1

Se fixeaza suportii polita (**SP**)x4 pe placile in gaurile indicate.

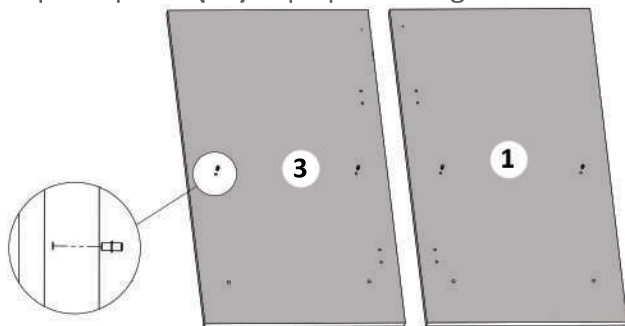

Pasul 2

Se prind placile (1) si (3) de placile (2) si (5) cu ajutorul confirmatoarelor (**C**)x6

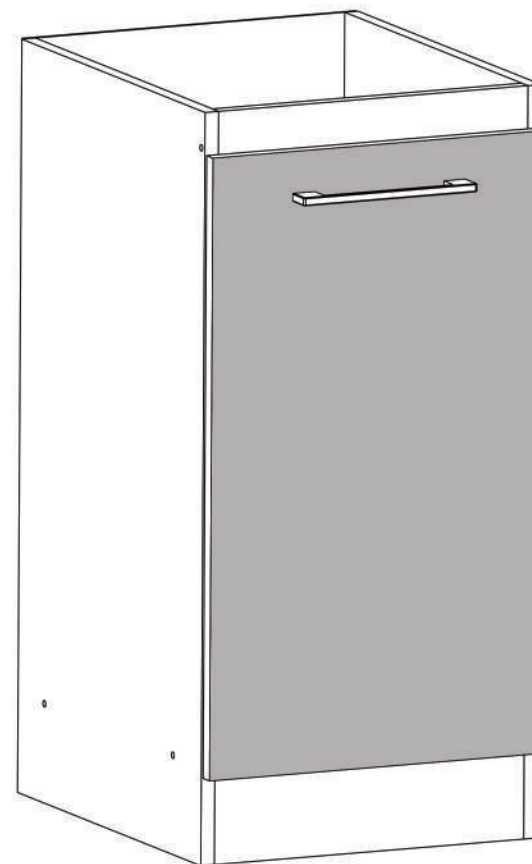
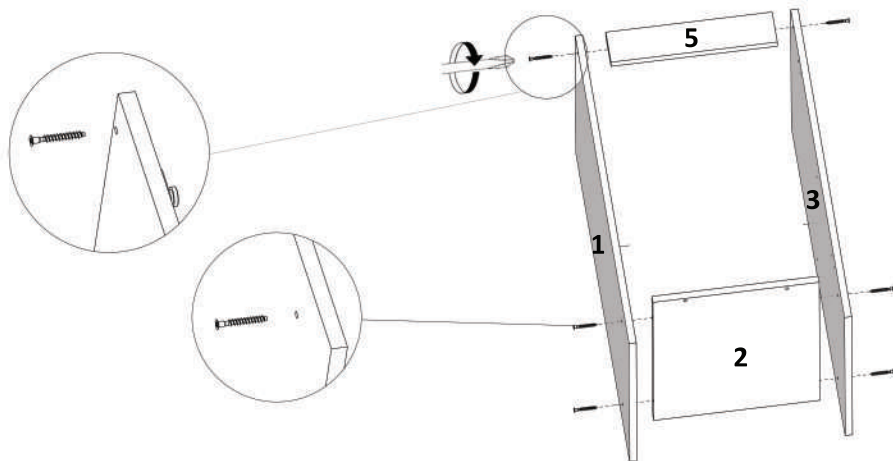

ANSAMBLU BUCATARIE MINA CI 600

Pasul 8 Montaj maner

Se fixeaza manerul cu ajutorul suruburilor **(S4)x2**, fiind necesara gaurirea usilor cu burghiu de 5mm in semnele indicate.

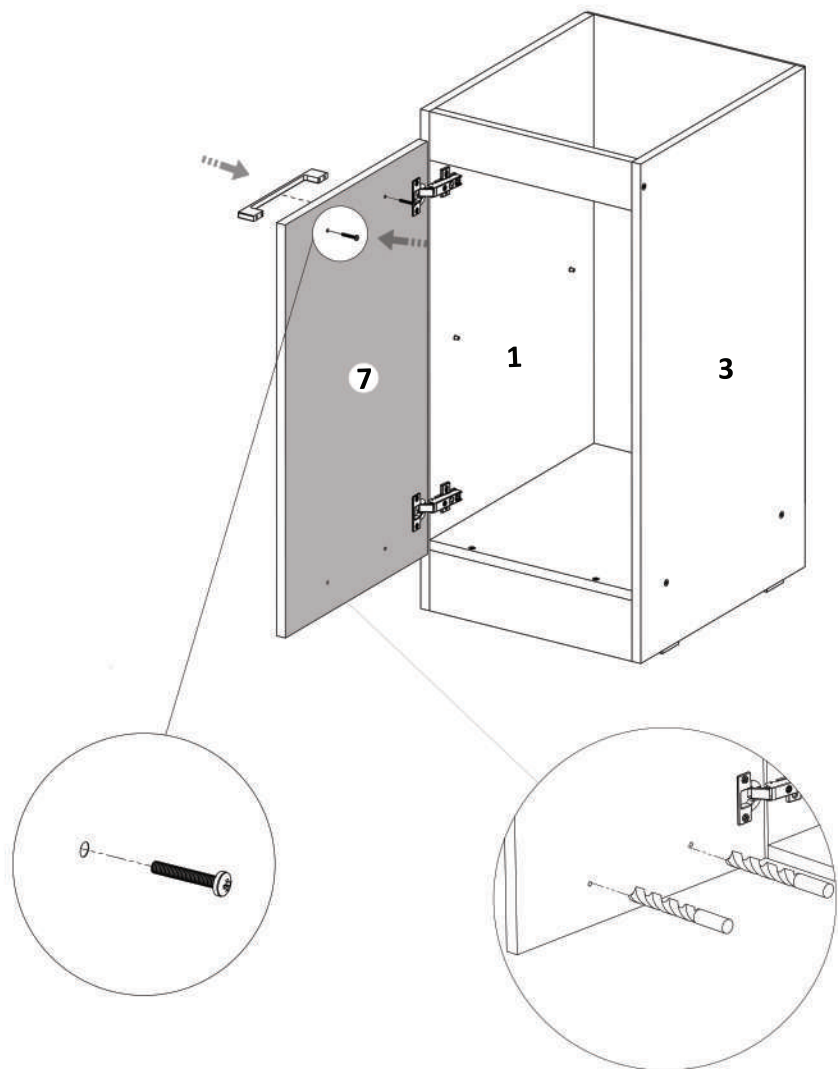

Pasul 3 - Montaj soclu

Se fixeaza placa (4) de placa (2) cu ajutorul confirmatoarelor **(C)x2**

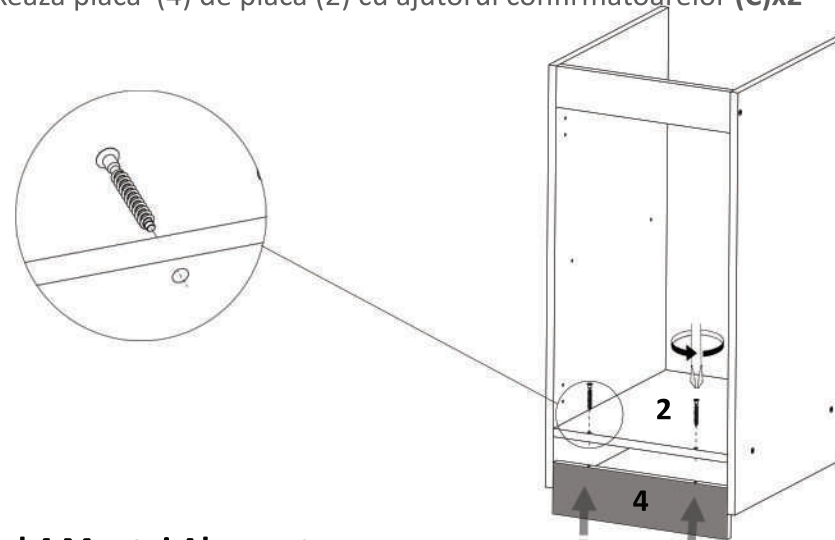

Pasul 4 Montaj Alunecatoare

Se fixeaza **(Ta)x4** pe placile (1) si (3) cu ajutorul suruburilor **(S3)x8**

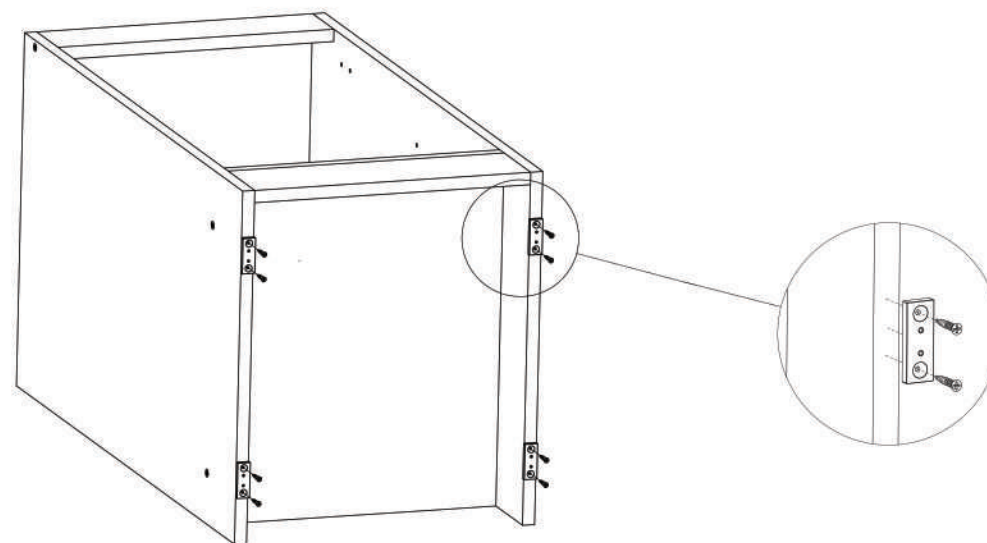

Pasul 5 Montaj Hdf

Se monteaza pe spatele corpului cu ajutorul cuielor (Cu)x17

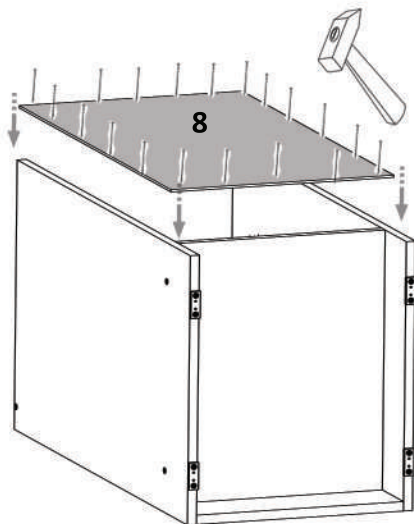

Se masoara diagonalele sa fie in vinclu inainte de a monta HDF-ul.



Pasul 6 Montaj balamale

Se monteaza balamalele cu ajutorul suruburilor 3.5x16 (S3)x4
Se pozitioneaza de la margine exact ca si in desen

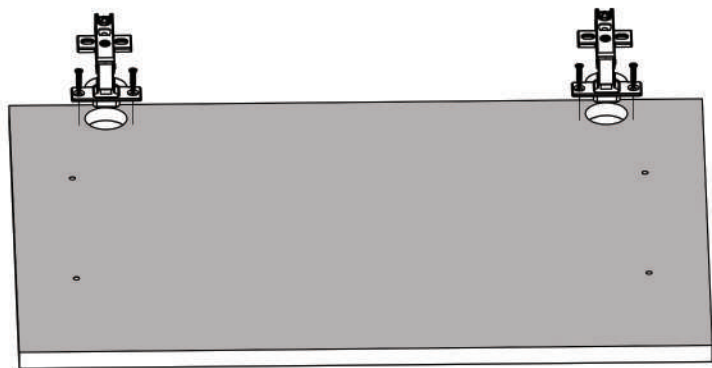

Pasul 7 Montaj Usa

Usa se monteaza cu ajutorul suruburilor 3.5x16 (S3)x4 in semnele indicate pe laterale.

