



Montajul necorespunzator atrage dupa sine pierderea garantiei.

Unelte Necesare:



Surubelnita







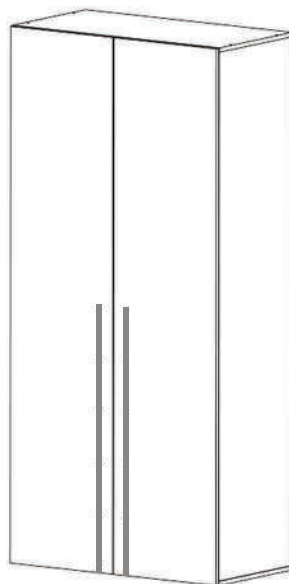

Ciocan



Imbus



Denumire	Dimensiune	Cantitate	Simbol
Laterală ST/DR	1952x458	2	LST/LDR
Baza / Tavan	926x458	2	BZ/TV
Polite Fixe	892x406	2	PF
Usa ST/DR	1980x458	2	US/UD
HDF	1980x458	2	HDF

CU  54	CF  16	BA  6	S4  6
S3  28	S5  8	B  8	PG  4
SC  12	PH  1	SH  2	

Ansamblare

1 Se prind **politele fixe (PF)** de **lateralele ST/DR** cu **8 confirmatoare (CF)**

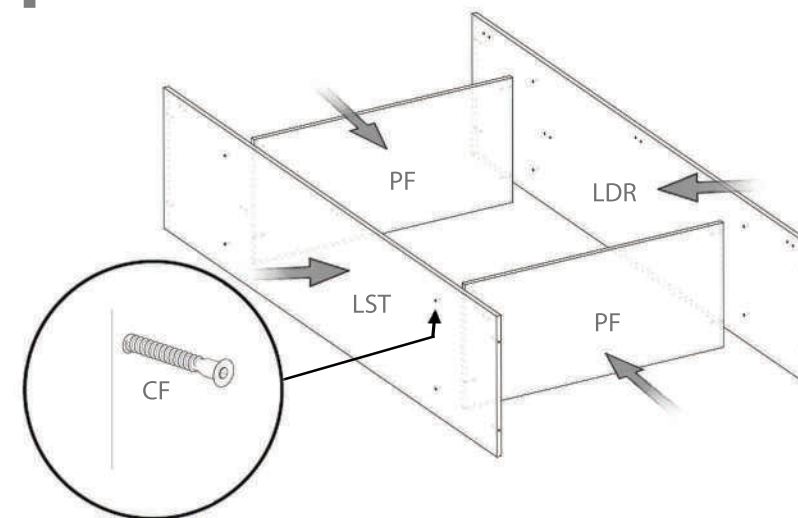

2 Se prinde **baza (BZ)** și **tavanul (TV)** de **lateralele ST/DR** cu **8 confirmatoare (CF)**

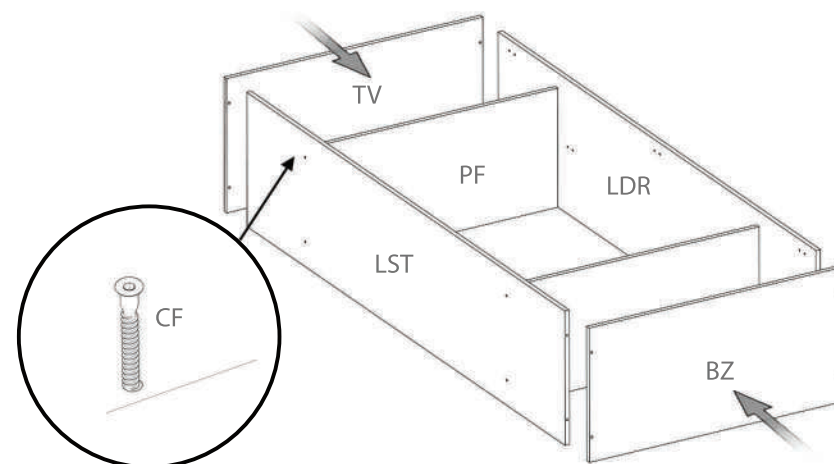

Montare HDF si Usi

Important:

Inainte de a prinde HDF-ul se va folosi o ruleta pentru a aduce in vinclu, corpul.

- 3** Se prinde **HDF-ul** pe spatele corpului de **LST, LDR, TV, BZ** si **PF** cu **54 cuie (CU)**

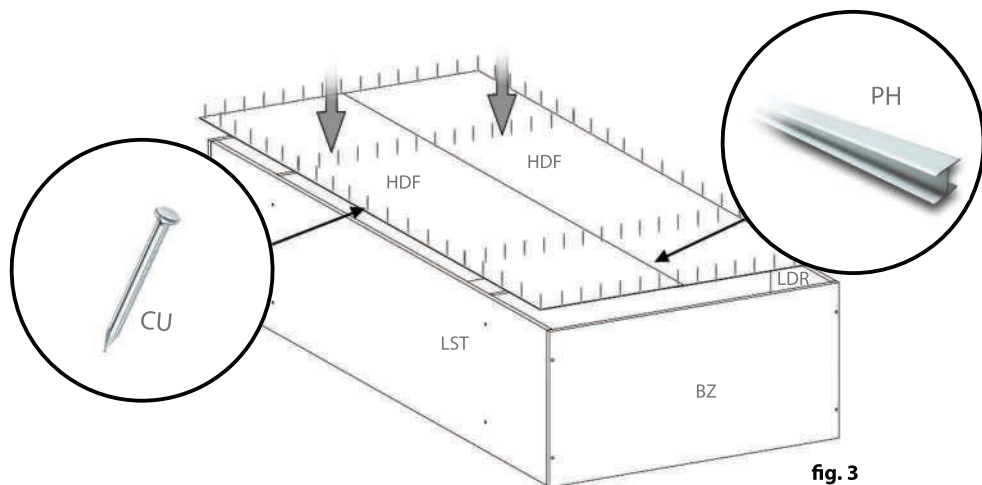
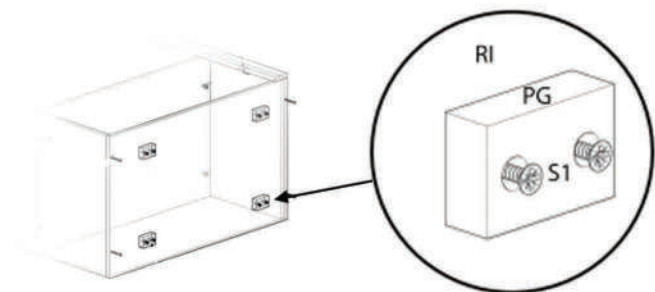
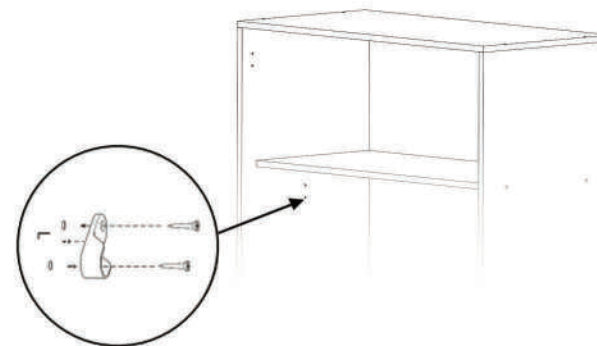

fig. 3

- 4** Se monteaza cele **4 picioare (PG)** pe **baza (BZ)** cu **8 surube 5x25 (S5)**



- 5** Se monteaza **suportii bara haine (SH)** pe **lateralele ST/DR** cu **4 surube 3,5x16 (S3)**, respectand semnele pentru pozitionarea acestora



- 6** Se prind cele **6 balamale aplicate (BA)** de **lateralele ST/DR** cu **24 surube 3,5x16 (S3)**

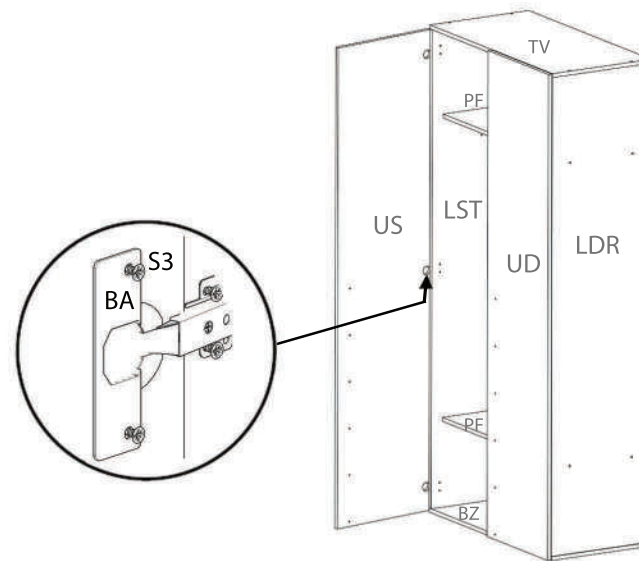

fig. 4



Important:

Montajul necorespunzator atrage dupa sine pierderea garantiei.