

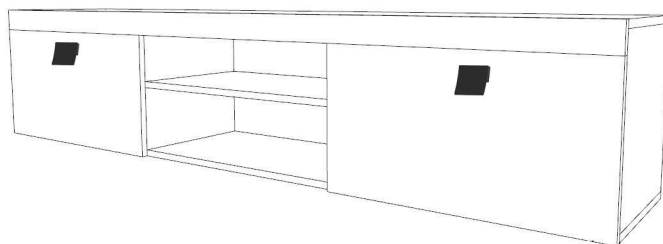

LAGUNA®

mobilă pentru acasă

COMODA TV



RO INSTRUCTIUNI DE MONTAJ
 EN INSTALLATION INSTRUCTIONS
 DE INSTALLATIONSANLEITUNG
 FR INSTRUCTIONS D'INSTALLATION
 IT ISTRUZIONI PER L'INSTALLAZIONE
 HU SZERELÉSI ÚTMUTATÓ
 UKR ІНСТРУКЦІЯ ПО МОНТАЖУ
 SRB УПУТСТВО ЗА ИНСТАЛАЦИЈУ
 BG ИНСТРУКЦИИ ЗА ИНСТАЛАЦИЯ
 RUS ИНСТРУКЦИЯ ПО МОНТАЖУ

| Denumire | Dimensiune | | Bucati | Simbol |
|--------------|------------|-----|--------|--------|
| Tavan | 1800 | 336 | 1 | T |
| Fund | 1800 | 336 | 1 | F |
| Laterale | 348 | 336 | 2 | L |
| Lezeta | 1800 | 60 | 1 | LZ |
| Polite | 600 | 336 | 1 | P |
| Intermediare | 348 | 336 | 2 | IM |
| Front | 600 | 316 | 2 | F |

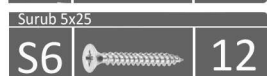
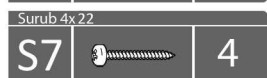
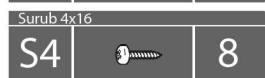
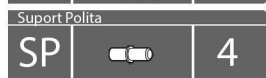
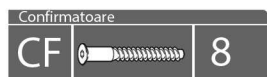

1 Montare

Se prind lateralele si intermediarele de capacul de jos al dulapului.

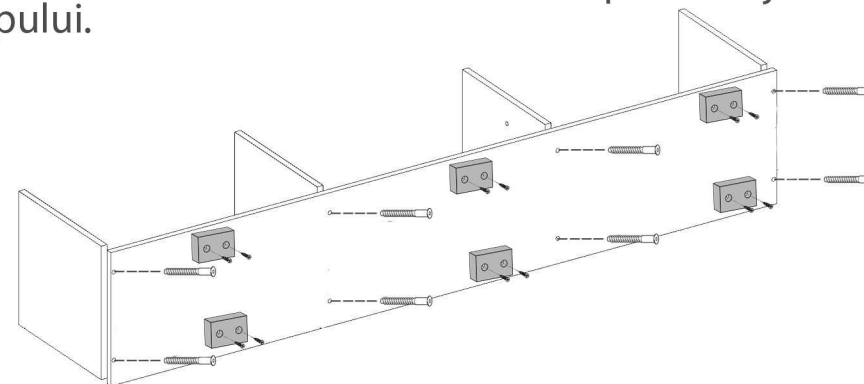

Picioarele de plastic gri (Pi) x 6buc se monteaza pe placa Fund (F) cu suruburi (S6) x 12 buc - cate 2 / picior.

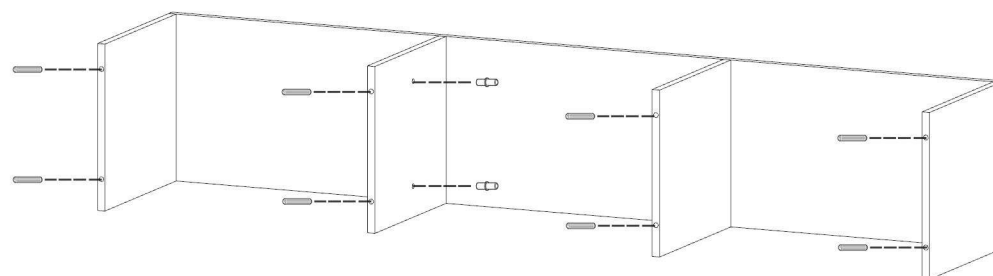

Pentru a prinde tavanul, vom folosi cepi de lemn, acestia se vor bate usor in laterale si intermediare.

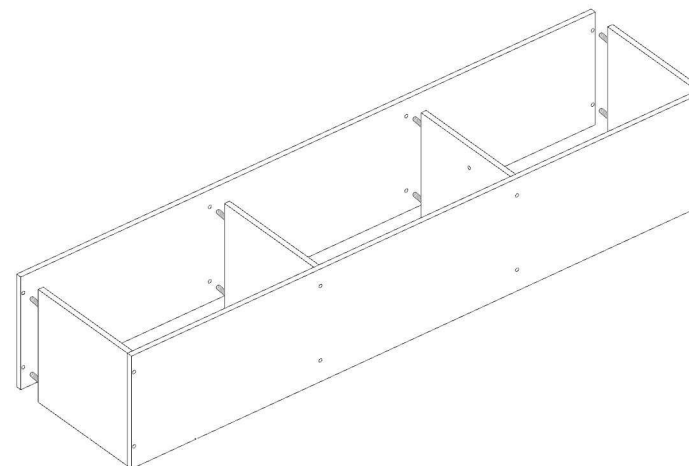



LAGUNA®

mobilă pentru acasă

COMODA TV

2 Montare HDF

Important! Inainte de a prinde HDF-ul de partea din spate a dulapului, acesta trebuie adus in vinclu, adica la 90 de grade.

Se va întoarce dulapul cu cantul spre podea, va ramane in pozitie orizontala, apoi se va prinde HDF-ul cu cuiute (C).

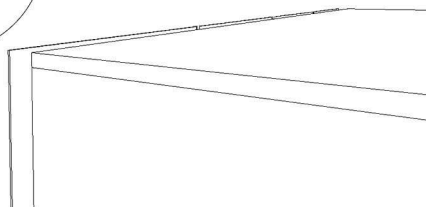
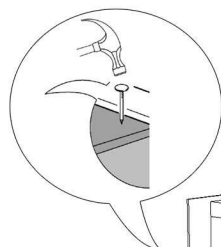

Dupa prinderea HDF-ului, se aseaza politele mobile pe suporti de polita (SP).

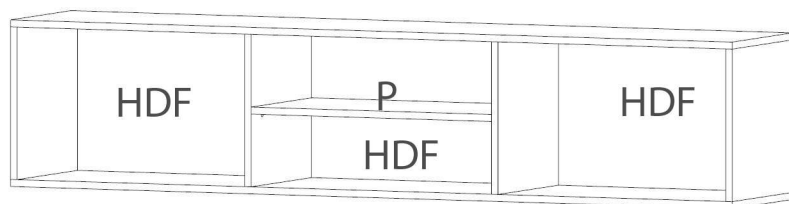

3 Montare lezene si front

Lezena se monteaza cu ajutorul coltarelor de plastic (CP) care se prind din interiorul dulapului.

Coltarele de plastic se vor prinde de tavan si de lezena cu surub 4x16(S4).

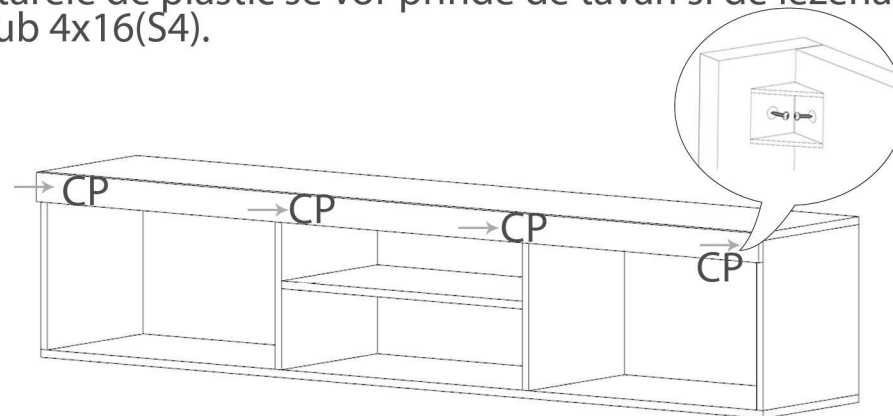

Prinderea balamalelor pe usi se face ca in desenul de mai jos.

Pentru prinderea balamalelor (BA) se vor folosi suruburile 3.5x16 (S5).

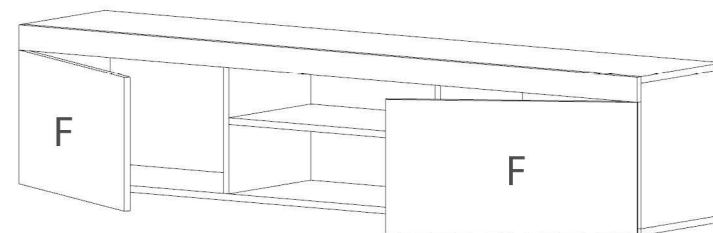
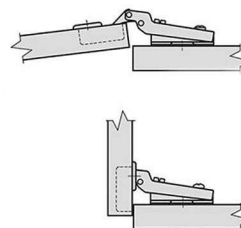

Se regleaza cu ajutorul unei surubelnite PZ2, frontul pentru a fi aliniat.

Manerele (M) se fixeaza pe front cu ajutorul suruburilor S7.



LAGUNA®

mobilă pentru acasă

COMODA TV

Montaj maner pe front (F)

Pasul 1. Se gaurește Frontul în partea superioară cu burghiu de 5 mm în locul unde sunt semnele.

Pasul 2. Se prinde manerul cu suruburi (S7) 4x22 - 2buc / maner.

