











# Birou Epic

KIT DEMONTABIL (tija + cama)	CONFIRMATOR 50mm	CONFIRMATOR 70mm	CUIE
<b>K</b>  22	<b>C5</b>  6	<b>C7</b>  5	<b>Q</b>  10
SURUB - 3.5 X 16 mm	SURUB - 3.5 X 40 mm	SURUB M4 x 25 mm	MANER
<b>S3</b>  36	<b>S7</b>  8	<b>M2</b>  4	<b>M</b>  2
Capac Plastic Alb/Bej/Negru	TALPA / protectie podea	SET GLISIERE	Autocolant Sonoma/Ferrara
<b>Cp</b>  10	<b>T</b>  6	<b>G</b>  2	<b>Cp</b>  2

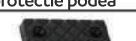

Denumire repere	Dimensiune repere
<b>1</b> Tavan 28 mm	1520x678 - 1 buc
<b>2</b> Lat. Dr. 28 mm	738x678 - 1 buc
<b>3</b> Spate birou 16 mm	969x288 - 1 buc
<b>4</b> Intermediara 28 mm	508x128 - 1 buc
<b>5</b> Tavan mic 28 mm	508x508 - 1 buc
<b>6</b> Lat. ST/DR 16 mm	566x492 - 2 buc
<b>7</b> Polita Fixa	474x492 - 1 buc
<b>8</b> Fund 16 mm	508x508 - 1 buc
<b>9</b> Spate birou 16 mm	508x612 - 1 buc
<b>10</b> Fata Sertar	502x184 - 2 buc
<b>11</b> Lat. sertar ST/DR	450x100 - 4 buc
<b>12</b> Capat Sertar	418x100 - 2 buc



## ATENȚIE!

Montajul necorespunzător atrage după sine, pierderea garanției produsului.



facebook.com/Mobilalaguna



www.mobilalaguna.ro



Acordați o atenție sporită!  
Posibilitate de accidentare!



Reciclează obiectele vechi de mobilier și ambalajul produselor LAGUNA. Protejează natura!

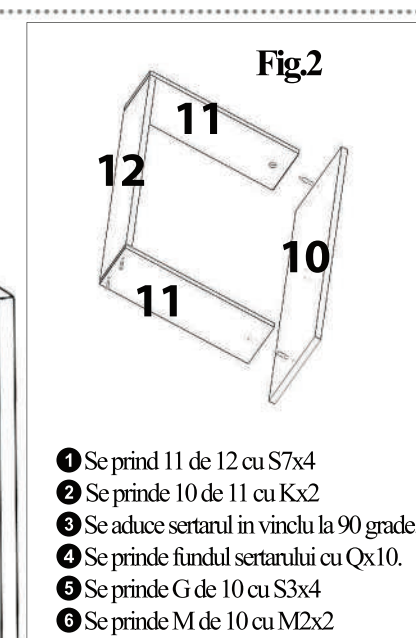
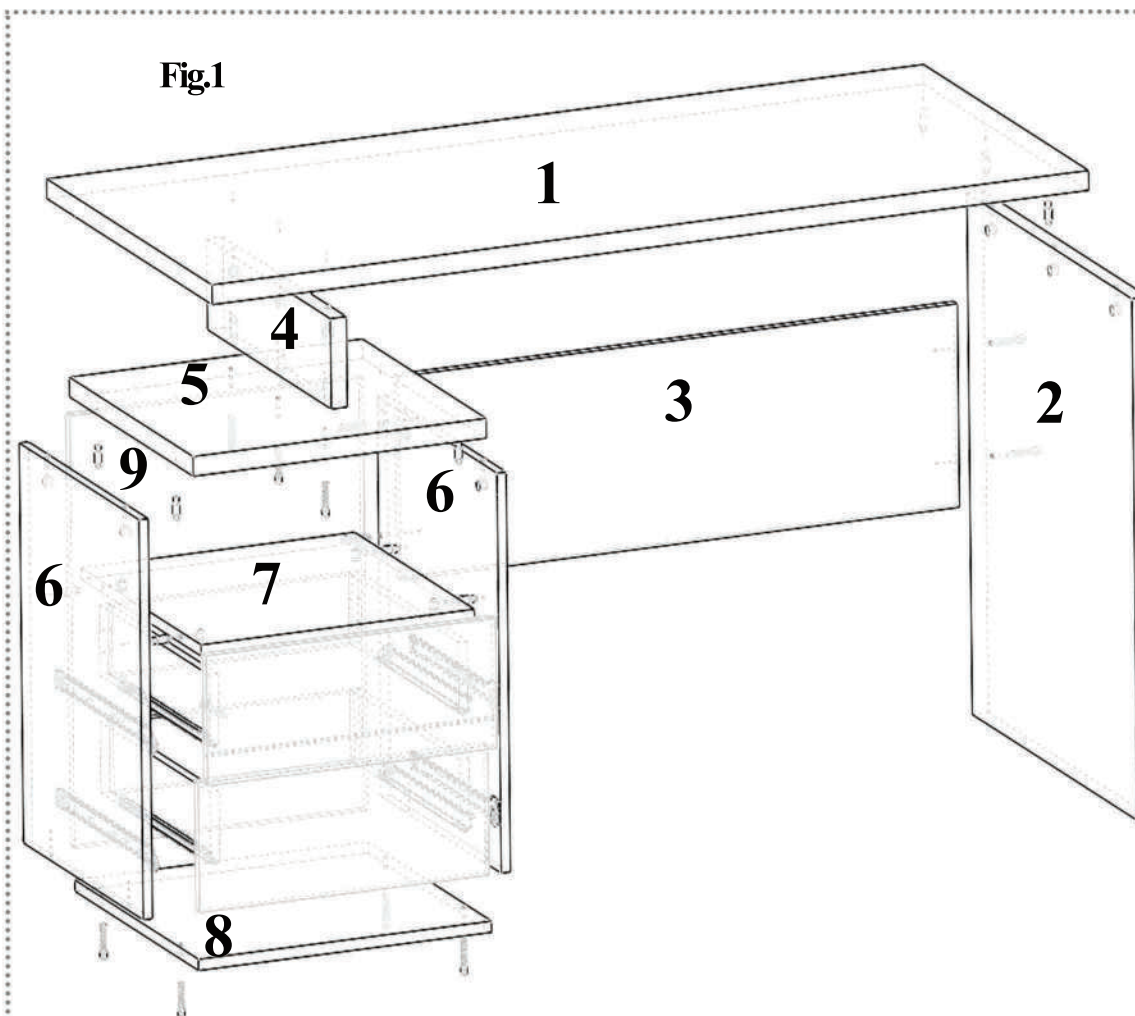

- 1** Se prind 11 de 12 cu S7x4
- 2** Se prinde 10 de 11 cu Kx2
- 3** Se aduce sertarul in vinclu la 90 grade.
- 4** Se prinde fundul sertarului cu Qx10.
- 5** Se prinde G de 10 cu S3x4
- 6** Se prinde M de 10 cu M2x2

- 1** Se prinde 2 și 4 de 1 cu 6xK
- 2** Se prinde G de 6 cu 8xS3
- 3** Se prinde 7 de 6 cu 4xK
- 4** Se prinde 6 de 5 cu 4xK
- 5** Se prinde 8 de 6 cu 4xC5
- 6** Se prinde 9 de 6 cu 4xK
- 7** Se montează sertarele după instrucțiunile din Fig.2
- 8** Se prinde 5 de 5 cu 3xC7
- 9** Se prinde 3 de 6 cu 2xC5 și de 2 cu 2xC7
- 10** Se prinde 6xT de 8 și 2 cu 12xS3
- 11** Se prinde Mx2 de 10 cu 4xM2

