



LAGUNA®

mobilă pentru acasă

DULAP HAINE



RO INSTRUCTIUNI DE MONTAJ
 EN INSTALLATION INSTRUCTIONS
 DE INSTALLATIONSANLEITUNG
 FR INSTRUCTIONS D'INSTALLATION
 IT ISTRUZIONI PER L'INSTALLAZIONE
 HU SZERELÉSI ÚTMUTATÓ
 UKR ІНСТРУКЦІЯ ПО МОНТАЖУ
 SRB УПУТСТВО ЗА ИНСТАЛАЦИЈУ
 BG ИНСТРУКЦИИ ЗА ИНСТАЛИРАНЕ
 RUS ИНСТРУКЦИЯ ПО МОНТАЖУ



Denumire	Dimensiune	Bucati	Simbol
Laterale	1748x288	2	L
Lezeta	676x60	1	LZ
Polita Fixa Inf.	647x288	1	PFI
Polita Fixa Sup.	647x288	1	PFS
Tavan	676 x288	1	T
Fund	676 x288	1	F
Front	1736x336	2	FR

Picioare plastic gri



Cuiute



Confirmatoare



1 Montare

Se fixeaza tavanul, fundul de cele doua laterale cu confirmatoare (CF), apoi se vor prinde cele doua polite fixe.

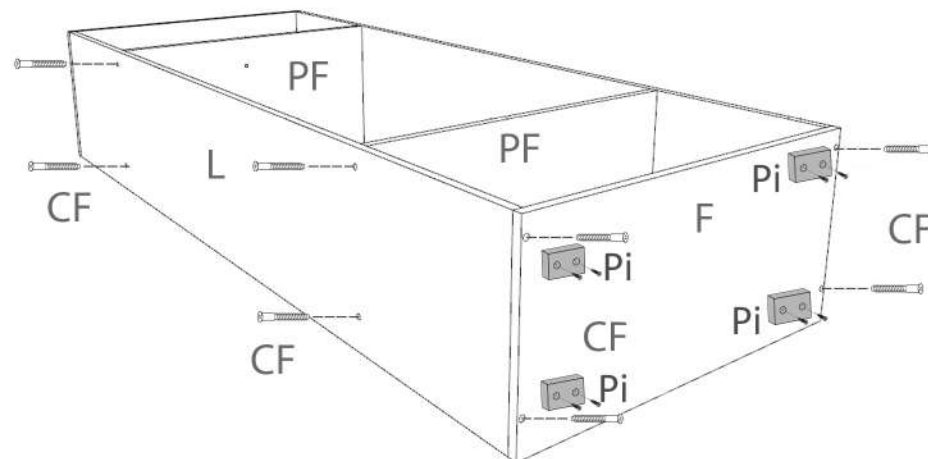

Picioarele de plastic gri (Pi) x 4buc se monteaza pe placa Fund (F) cu suruburi (S6) x 8 buc - cate 2 / picior.

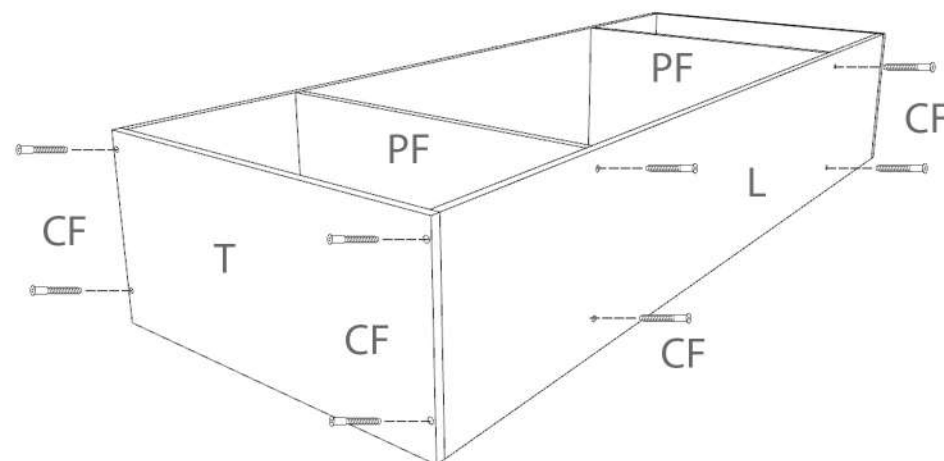



LAGUNA®

mobilă pentru acasă

DULAP HAINE

2 Montare HDF

Important! Inainte de a prinde HDF-ul de partea din spate a dulapului, acesta trebuie adus in vinclu, adica la 90 de grade.

Se va întoarce dulapul cu cantul spre podea, va ramane in pozitie orizontala, apoi se va prinde HDF-ul cu cuiute (C)

La imbinari se foloseste profilul de plastic tip H.

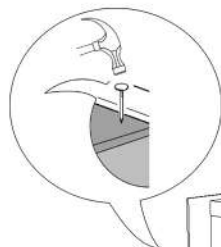
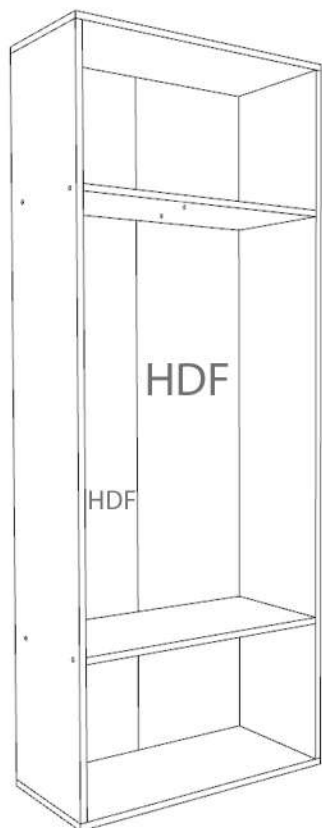

Dupa ce HDF-ul a fost prins dulap se va întoarce cu cantul spre tavan si se va monta suportul de umerase (SU). Suportul pentru umerase se va prinde cu surub M4x27(S3) pe polita fixa (PF) din partea de sus a dulapului.

3 Montare lezene si front

Lezena(LZ) se monteaza cu ajutorul coltarelor de plastic (CP) care se prind din interiorul dulapului. Coltarele de plastic se vor fixa de tavan si lezena(LZ) cu surub 4x16(S4).

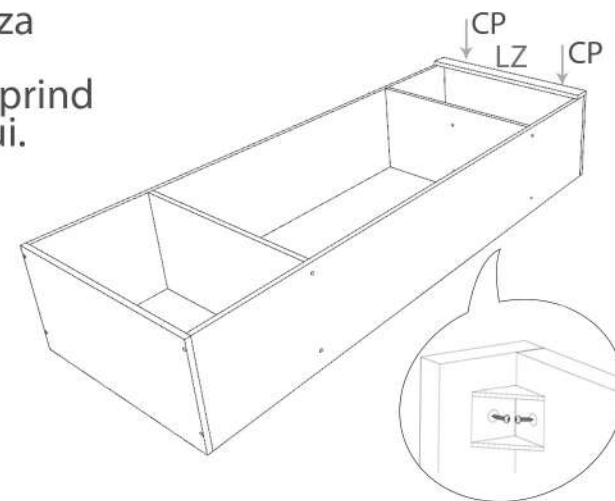

Prinderea balamalelor pe fronturi se face ca in desenul de mai jos.

Pentru prinderea balamalelor (BA) se vor folosi suruburile 3.5x16 (S5).

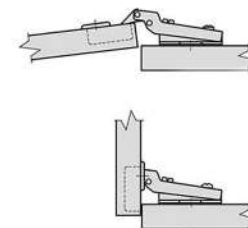
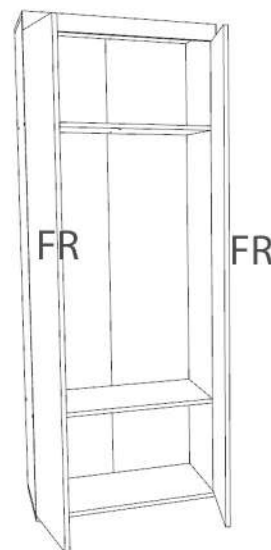

Se regleaza cu ajutorul unei surubelnite PZ2, frontul pentru a fi aliniat. Manerul(M) se fixeaza pe front cu ajutorul suruburilor S7