









Masută Robusta

KIT DEMONTABIL (tija + cama)	CONFIRMATOR 50mm	CONFIRMATOR 70mm	CUIE
K  12	C5  2	C7  6	Q  10
SURUB - 3.5 X 16 mm	SURUB - 5 X 25 mm	SURUB - 3.5 X 40 mm	SURUB M4 x 25 mm
S3  16	S5  8	S7  4	M2  2
Capac Plastic Negru/Bej	TALPA / protectie podea	SET GLISIERE	MANER
Cp  4	T  4	G  1	M  1

Denumire repere	Dimensiune repere
1 Fund 28 mm	1033x508 - 1 buc
2 Lat. St. 16 mm	458x200 - 1 buc
3 Lat. Dr. 16 mm	458x200 - 1 buc
4 Tavan 16 mm	815x458 - 1 buc
5 Intermediara 28 mm	300x131 - 1 buc
6 Lat. Dr. 28 mm	508x347 - 1 buc
7 Tavan 28 mm	700x508 - 1 buc
8 Placa Spate 16 mm	811x212 - 1 buc
9 Fata Sertar 16 mm	811x212 - 1 buc
10 Lat. sertar St/Dr	400x120 - 2 buc
11 Capat sertar	727x120 - 1 buc

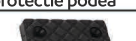



ATENȚIE!

Montajul necorespunzator atrage după sine, pierderea garanției produsului.

 facebook.com/MobilaLaguna

 www.mobilalaguna.ro

 Acordati o atentie sporita!
Posibilitate de accidentare!

 Recicleaza obiectele vechi de mobilier si ambalajul produselor LAGUNA. Protejeaza natura!

 **LAGUNA**[®]
mobilă pentru acasă

- 1 Se prinde 2,3 si 6 de 1 cu C7x6
- 2 Se prinde 4 de 2 si 3 cu Kx4
- 3 Se prinde 5 de 4 cu C5x2
- 4 Se prinde 7 de 5 si 6 cu Kx4
- 5 Se prinde G de 2 si 3 cu S3x4
- 6 Se prinde Tx4 de 1 cu S5x8

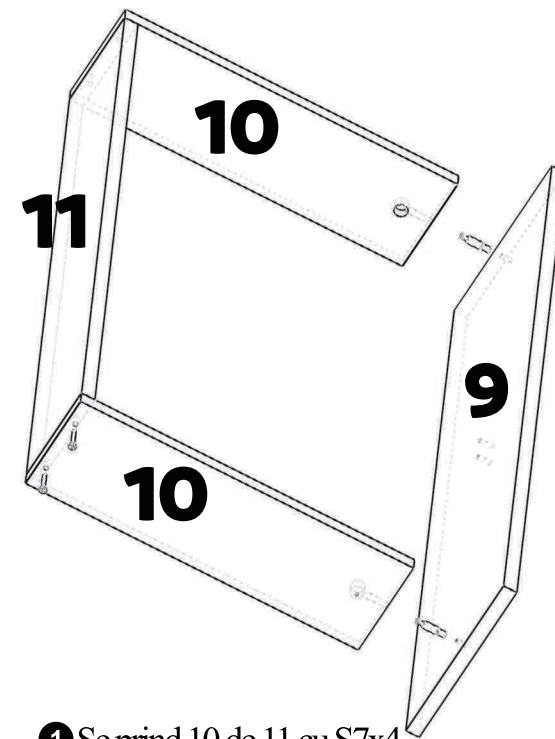
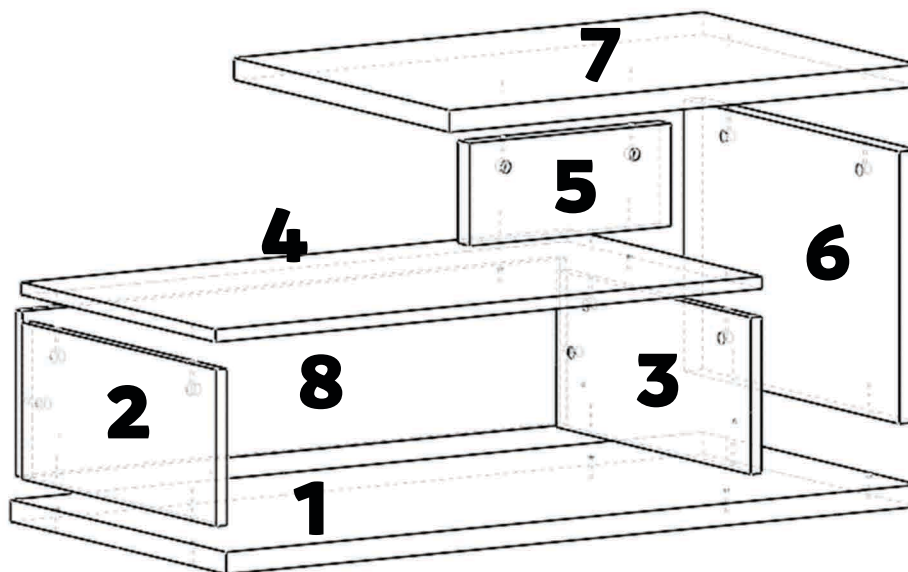

- 1 Se prind 10 de 11 cu S7x4
- 2 Se prinde 10 de 9 cu Kx2
- 3 Se aduce sertarul in vinclu la 90 grade.
- 4 Se prinde fundul sertarului cu Qx10.
- 5 Se prinde G de 10 cu S3x4
- 6 Se prinde M de 9 cu M2x2

