

DRESSING KENT



ATENȚIE!

Montajul necorespunzător atrage după sine, pierderea garanției produsului.



facebook.com/MobilaLaguna



www.mobilalaguna.ro



Acordați o atenție sporită!
Posibilitate de accidentare!



Recicleaza obiectele vechi de mobilier și ambalajul produselor LAGUNA. Protejeaza natura!



LAGUNA[®]
mobilă pentru acasă



50

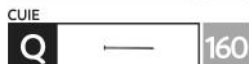

160



4



8



40



8

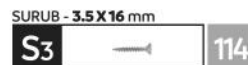

114

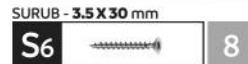

8

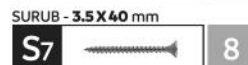

8



2



1



4



14



24



8



18



4



3

SIMBOL	BUCATI	DENUMIRE
T	1	TAVAN DIMENSIUNI REPER: 2016 X 508
F	1	FUND DIMENSIUNI REPER: 2016 X 508
L	2	PERETE LATERAL DIMENSIUNI REPER: 2093 X 508
CS	2	CAPAT SERTAR DIMENSIUNI REPER: 334 X 100
LS	4	LATERALA SERTAR DIMENSIUNI REPER: 400 X 100
FS	2	FRONT SERTAR DIMENSIUNI REPER: 415 X 148

SM	2	SOCLURI MARI DIMENSIUNI REPER: 2016 X 62
LO	1	LEZENA ORIZONTALA DIMENSIUNI REPER: 2016 X 80
LV	2	LEZENA VERTICALA DIMENSIUNI REPER: 2157 X 80
PLS	2	PERETE LATERAL SERTARE DIMENSIUNI REPER: 407 X 296
PM	6	POLITE MOBILE DIMENSIUNI REPER: 488 X 407

PF	2	POLITE FIXE DIMENSIUNI REPER: 1000 X 407
PIm	1	PERETE INTERMEDIAR MIC DIMENSIUNI REPER: 1593 X 407
PIM	1	PERETE INTERMEDIAR MARE DIMENSIUNI REPER: 1999 X 508
UG	2	USI CU ORNAMENT GRI DIMENSIUNI REPER: 2013 X 552
UO	2	USI CU OGLINDA DIMENSIUNI REPER: 2013 X 446

HD	4	HDF SPATE DULAP DIMENSIUNI REPER: 2025 X 508
HS	2	HDF SERTARE DIMENSIUNI REPER: 405 X 362
EG	2	ELEMENT ORNAMENT GRI DIMENSIUNI REPER: 250 X 150
TS	1	TAVAN SERTARE DIMENSIUNI REPER: 100 X 407
Sm	2	SOCLURI MICI DIMENSIUNI REPER: 470 X 62

REPERE

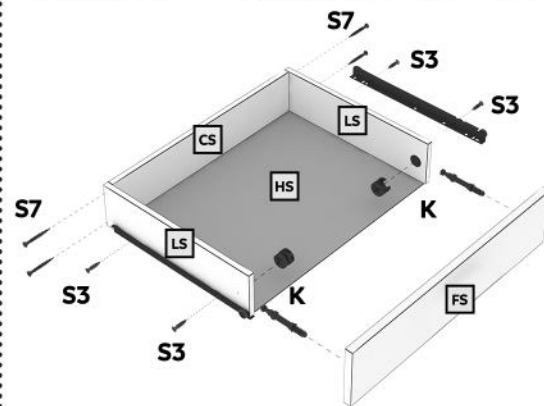

MONTAJUL SERTARELOR

- Se fixeaza **LS** cu **CS** prin 4 x **S7**
- Se fixeaza **LS** cu **FS** prin 2 x **K**
- Se fixeaza **G** (glisierile) cu **S3**
- Se fixeaza **M** (maner patrat) cu 2 x **M2**
- Se aduce sertarul la unghi de 90 și se fixeaza fundul de sertar cu **Q** (cuie)

- Se fixeaza fundul **F** de **soclurile mici si mari** (**SM** și **Sm**) prin confirmatoare **C5**
- Se fixeaza **T** cu **S3** de **soclurile mici**, cate 2 buc / soclu

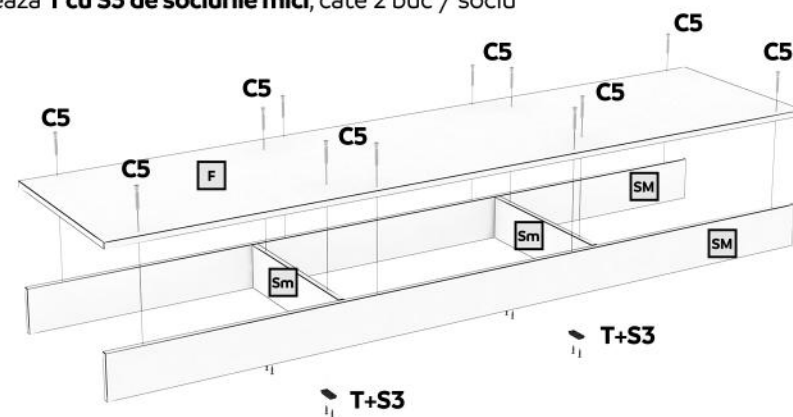

- 1 Se fixeaza **L (stang si drept)** cu **F** prin 6 x **confirmatoare C5**
- 2 Se fixeaza **L (stang si drept)** cu **T** prin 6 x **confirmatoare C5**
- 3 Se fixeaza **PIM (perete intermediar mare)** cu **T si F** prin 6 x **confirmatoare C5**
- 4 Se fixeaza **2 x PF** de **L** si **PIM** cu **2 x 4 x confirmatoare C5**
- 5 Se fixeaza **Pim** (perete intermediar mic) de **PF (dreapta)** si **F** cu **4 x confirmatoare C5**
- 6 Se fixeaza **talpi (T)** de **L** cu **4 x 2 x S3**

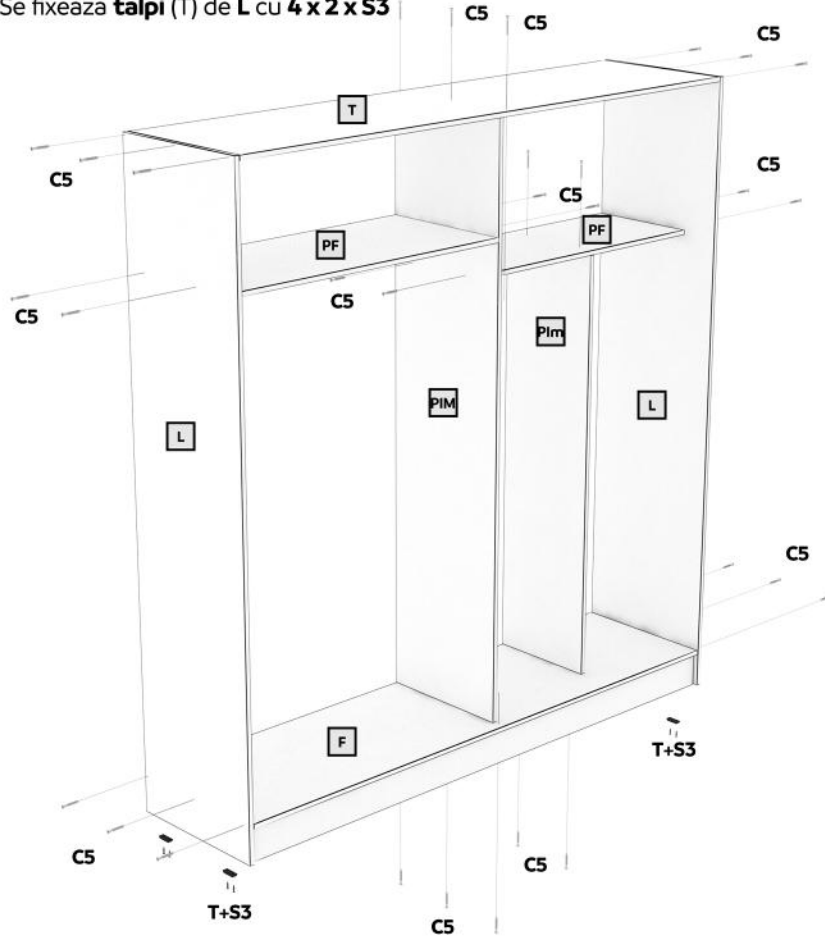

- 1 Se monteaza glisierile pe **PLS (stang si drept)** cu **2 x 4 x S3**
- 2 Se fixeaza **PLS (stang si drept)** cu **F** prin 4 x **confirmatoare C5**
- 3 Se fixeaza **TS** cu **PLS** prin 4 x **CEPI LEMN (W)**
- 4 Se fixeaza **TS** de **L** si **PIM** cu **4 x confirmatoare C5**
- 5 Se fixeaza **bara haine (H)** cu **suportii bara haine si suruburi S3**
- 6 Se aduce corpul la vinclu de 90 si se fixeaza **HDF** cu **Q (cuie)** si saibe **R**

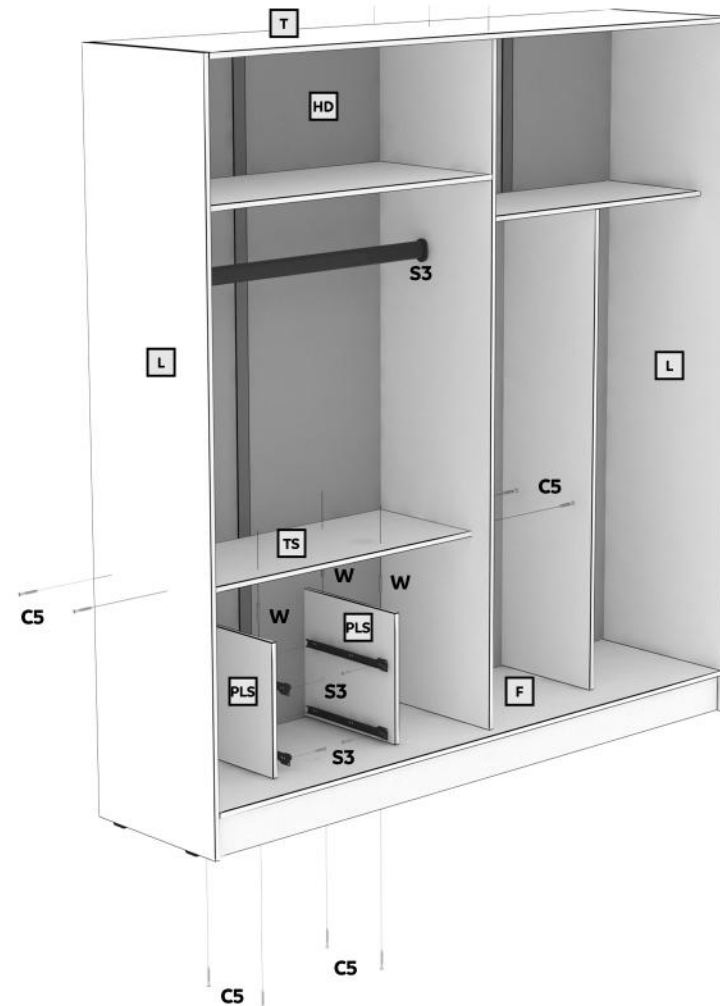

Probabilitate mare de
a incurca suruburile!



Utilizati
imburi



Recomandat a fi
montat de 2 pers



Aplicati
aracet



Strangeti camele
in sensul + indicat



Utilizati un
ciocan



Utilizati o
surubelnita



Utilizati o
surubelnita



- 1 Se pozitioneaza politele mobile **PM** cu **4 x P** (suport polita) **pe fiecare polita**
- 2 Se fixeaza **coltarele V4** pe tavan **T** prin suruburi S3
- 3 Se fixeaza **lezele verticale (LV)** cu **cea orizontala (LO)** cu **4 placute "i"** si **4 x 4 suruburi S3**
- 4 Se fixeaza **pe lezele verticale cate 5 cepi lemn** si se fixeaza tot ansamblul in cepi lemn pe **L** (stanga si dreapta)
- 5 Se prinde lezna superioara orizontala **LO** in coltarele **V4** folosind **suruburi S3**

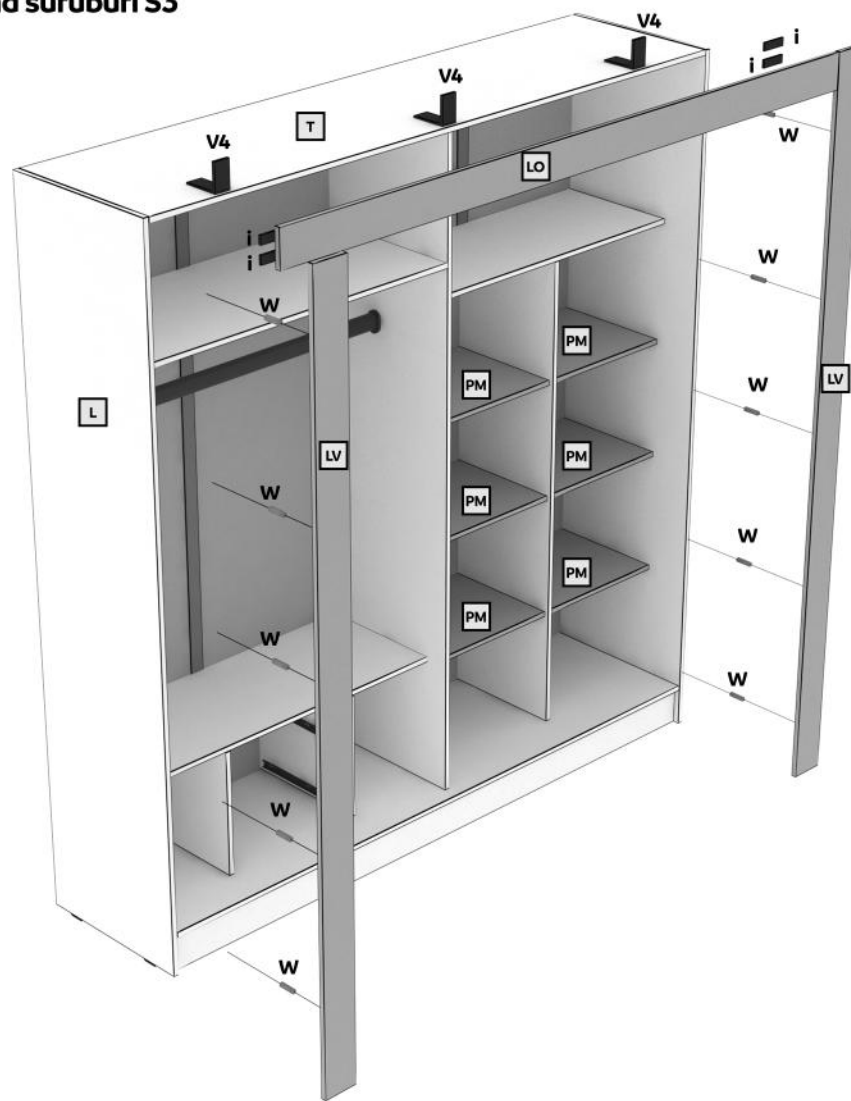

Probabilitate mare de a incurca suruburile!



Utilizati imbus



Recomandat a fi montat de 2 pers



Aplicati aracet



Strangeti camele in sensul + indicat



Utilizati un ciocan



Utilizati o surubelnita



- 1 Se fixeaza **elementele EG** cu 2 x 4 **suruburi S6**
- 2 Se fixeaza **usile cu ornament** prin balamale incadrate si suruburi S3
- 3 Se fixeaza **usile cu oglinda** prin balamale semiaplicate si suruburi S3

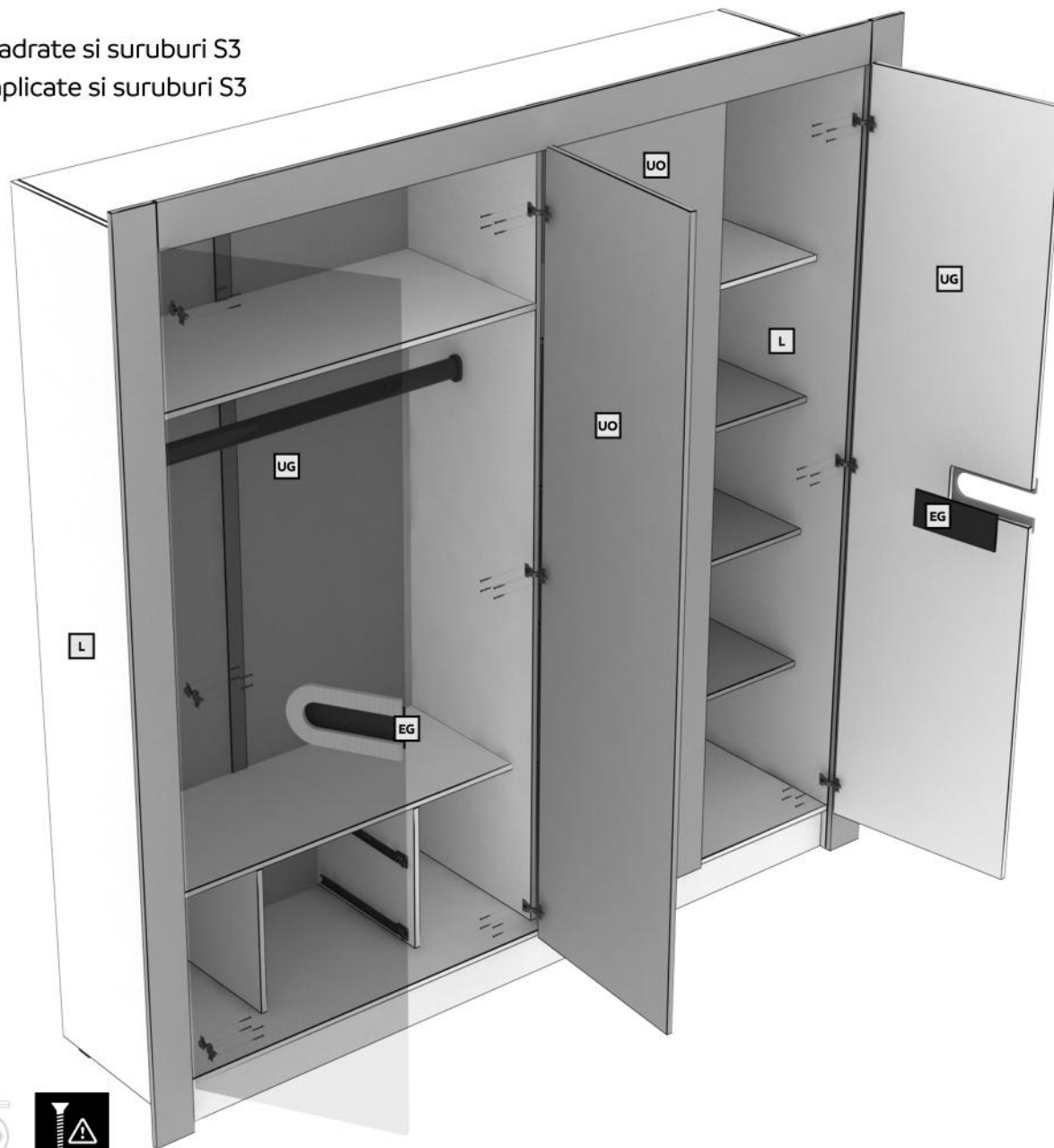

- Utilizati o surubelnita
- Utilizati un ciocan
- Strangeti camele in sensul + indicat
- Aplicati aracet
- +1
- Recomandat a fi montat de 2 pers
- Utilizati imbus
- Probabilitate mare de a incurca suruburile!

COMODA KENT



ATENȚIE!

Montajul necorespunzător atrage după sine, pierderea garanției produsului.



facebook.com/MobilaLaguna



www.mobilalaguna.ro



Acordați o atenție sporită!
Posibilitate de accidentare!



Reciclează obiectele vechi de mobilier și ambalajul produselor LAGUNA. Protejează natura!



LAGUNA[®]
mobilă pentru acasă

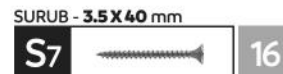
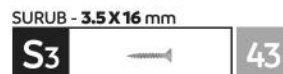

REPERE

SIMBOL	BUCATI	DENUMIRE
T	1	TAVAN DIMENSIUNI REPER: 742 X 420
F	1	FUND DIMENSIUNI REPER: 742 X 430
PL	2	PERETI LATERALI DIMENSIUNI REPER: 1010 X 430
CS	4	CAPAT SERTAR DIMENSIUNI REPER: 652 X 140
LS	8	LATERALA SERTAR DIMENSIUNI REPER: 400 X 140
FS	3	FATA SERTAR ④ DIMENSIUNI REPER: 249 X 701
FO	1	FATA SERTAR CU ORNAMENT ⑤ DIMENSIUNI REPER: 701 X 243
CG	1	CAPAT SERTAR (GRI PIATRA) ⑥ DIMENSIUNI REPER: 655 X 140
HDF	2	HDF SPATE COMODA DIMENSIUNI REPER: 1055 X 365
HS	4	HDF SERTAR DIMENSIUNI REPER: 405 X 684

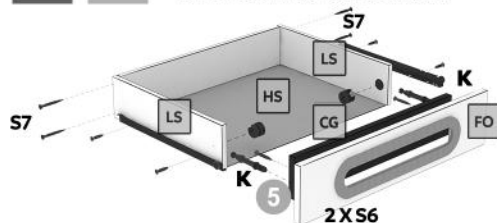

- Se fixează **PL** cu **F** prin 4 x **C5** (confirmatoare)
- Se fixează **T** cu **PL** prin 2 x 2 x **K**
- Se fixează **G** (glisierile) cu **S3** de **PL** stanga și dreapta
- Se fixează **T** cu 2 x **S3** de **F** (fund)
- Se aduce corpul la unghi de 90 și se fixează **HDF - HN** cu **Q** (cuie)
- Se strâng **K** și se poziționează **sertarul pe glisieră**

MONTAJUL SERTARELOR

- Se fixează **LS** cu **CS** prin 4 x **S7**
- Se fixează **LS** cu **FS** prin 2 x **K**
- Se fixează **G** (glisierile) cu **S3**
- Se fixează **M** (maner patrat) cu 2 x **M2**
- Se fixează **CG** (capat sertar gri) cu 2 x **S6** de **FO**! doar la sertarul de sus!
- Se aduce sertarul la unghi de 90 și se fixează fundul de sertar cu **Q** (cuie)

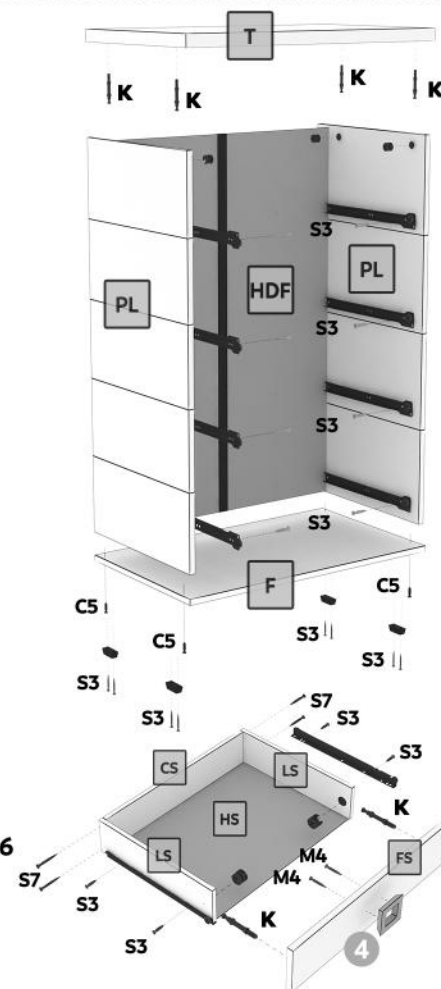

PAT FIX KENT



ATENȚIE!

Montajul necorespunzător atrage după sine, pierderea garanției produsului.



facebook.com/MobilaLaguna



www.mobilalaguna.ro



Acordați o atenție sporită!
Posibilitate de accidentare!











Reciclează obiectele vechi de mobilier și ambalajul produselor LAGUNA. Protejează natura!



LAGUNA[®]
mobilă pentru acasă

FERONERIE

CONFIRMATOR 7x50mm C5  20	SURUB - 3.5 X 30 mm S6  42
CONFIRMATOR 70mm C7  4	KIT DEMONTABIL (tija + cama) K  4
COLTAR 50 mm V5  8	CUIE Q  24
SURUB - 3.5 X 16 mm S3  16	CEP LEMN W  4
	TALPA / protecție podea T  9

REPERE

SIMBOL	BUCATI	DENUMIRE
CP	1	CAPAT MARE PAT DIMENSIUNI REPER: 1650 X 1000
CM	1	CAPAT MIC PAT DIMENSIUNI REPER: 1632 X 210
LP	2	LATERALE PAT DIMENSIUNI REPER: 2000 X 210
SS	2	SUPORT SALTEA DIMENSIUNI REPER: 1996 X 796
SL	1	SUPORT SALTEA LUNG DIMENSIUNI REPER: 1968 X 210
SC	4	SUPORT SALTEA SCURT DIMENSIUNI REPER: 776 X 210
CS	6	CAPAT SUPORTURI PAT DIMENSIUNI REPER: 288 X 105
Pm	4	PICIOARE MICI DIMENSIUNI REPER: 205 X 134
PM	2	PICIOARE MARI DIMENSIUNI REPER: 205 X 150

- 1 Se fixează SC de SL prin câte 2 confirmatoare C5
- 2 Se fixează CS de SC prin câte 2 confirmatoare C5

La acest pas se folosesc toate cele 20 de confirmatoare C5
Pentru strângerea confirmatoarelor se utilizează cheia imbus

ASS - ANSAMBLU SUPT SALTEA

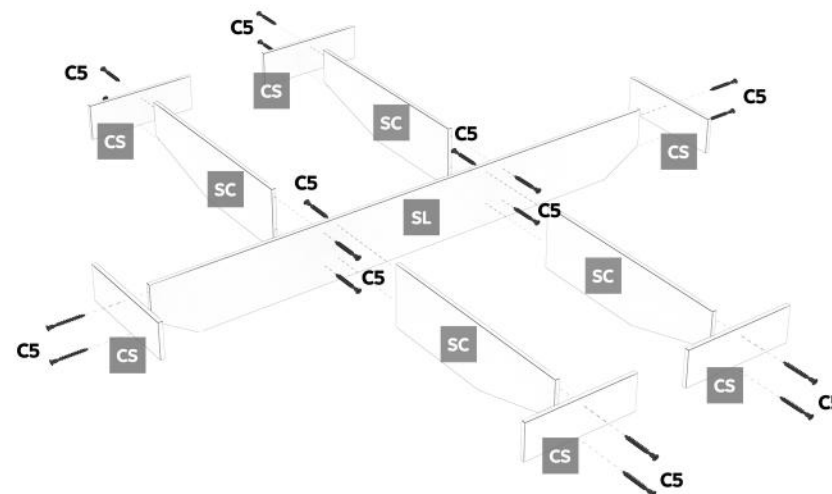

3 Se aseză lateralele lângă ansamblul (ASS) construit anterior.

Se prind lateralele cu capetele patului (LP cu CP) prin câte 2 confirmatoare C7 (70mm)

Se fixează LP de Cm cu 4 x kit demontabil (K).

4 Se fixează lateralele și capetele patului (LP, CP, CM) de ansamblul suport pentru saltea ASS, utilizând câte 4 suruburi S6 pentru fiecare CS (capat suport pat).

5 Se fixează cele 4 picioare mici (Pm) prin câte 2 cepi de lemn (W)

OK 1 ORNAMENT PIATRA GRI KENT

DIMENSIUNI REPER: 1400 X 150

Elementul OK - ornament se fixează în spatele canalului frezat al capatului de pat (CP) prin suruburi S6

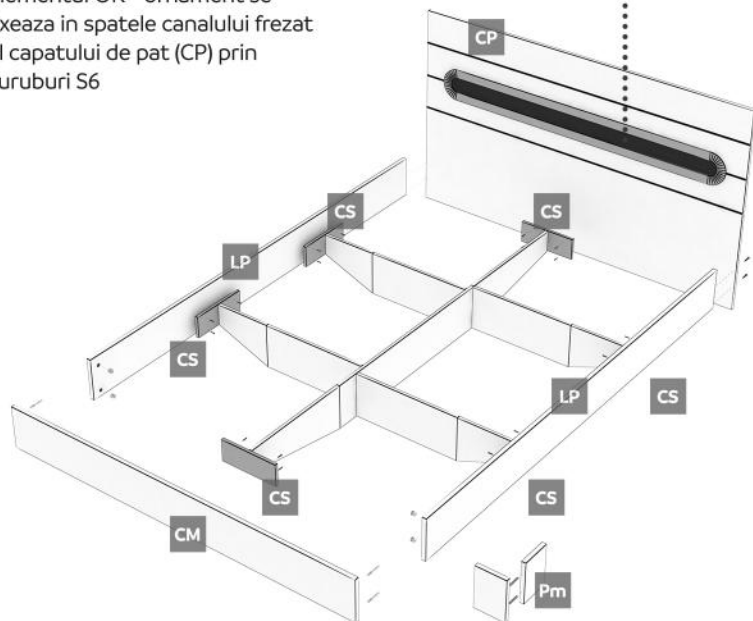

6 Se montează picioarele Pm și PM, utilizând câte 2 surub S6 pentru fiecare picior. În total vor fi folosite 12 suruburi

7 Se prind LP cu CP prin câte 1 colțar V5 și suruburi 16 x S3.

8 Se prind T folosind cuie Q.

Se aseză suportul pal de saltea și salteaua, dacă aceasta a fost achiziționată odată cu patul, sau se achiziționează o saltea cu dimensiuni corespunzătoare.

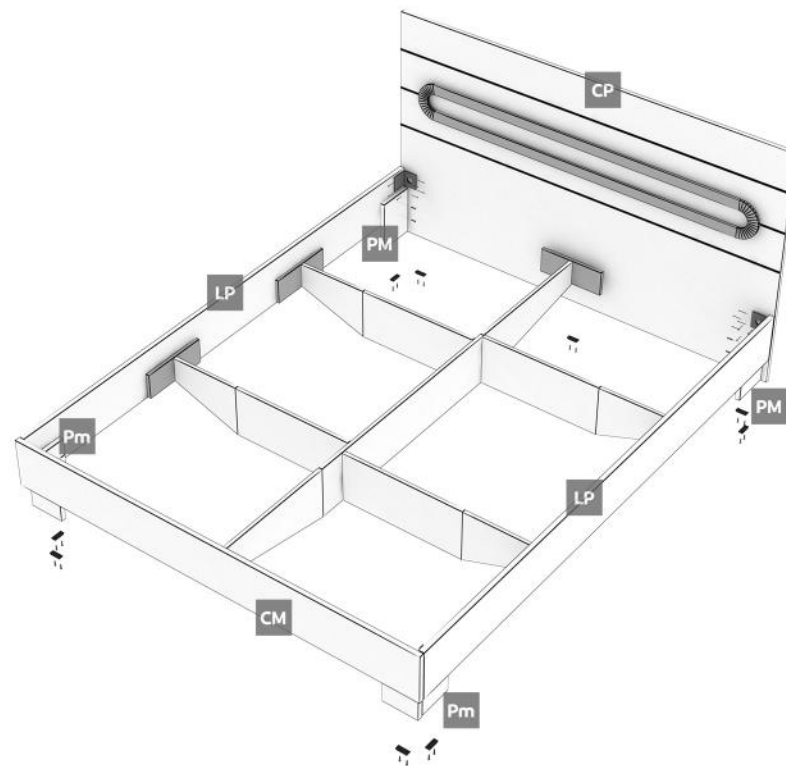

NOPTIERA KENT



ATENȚIE!

Montajul necorespunzător atrage după sine, pierderea garanției produsului.



facebook.com/MobilaLaguna



www.mobilalaguna.ro



Acordați o atenție sporită!
Posibilitate de accidentare!



Reciclează obiectele vechi de mobilier și ambalajul produselor LAGUNA. Protejează natura!



LAGUNA[®]
mobilă pentru acasă

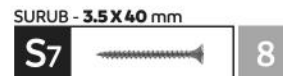
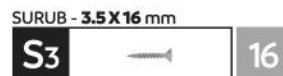

REPERE

SIMBOL	BUCATI	DENUMIRE
T	1	TAVAN DIMENSIUNI REPER: 458 X 340
F	1	FUND DIMENSIUNI REPER: 422 X 302
PL	2	PERETI LATERALI DIMENSIUNI REPER: 343 X 340
CS	4	CAPAT SERTAR DIMENSIUNI REPER: 365 X 100
LS	8	LATERALA SERTAR DIMENSIUNI REPER: 300 X 100
FS	3	FATA SERTAR ALB DIMENSIUNI REPER: 417 X 153
HDF	2	HDF SPATE NOPTIERA DIMENSIUNI REPER: 450 X 195
HS	4	HDF SERTAR DIMENSIUNI REPER: 395 X 305

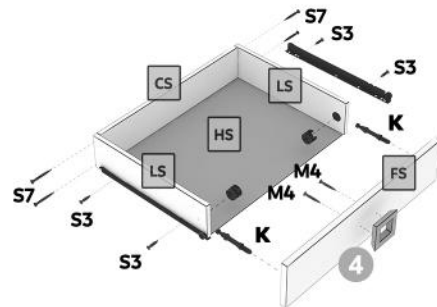

- 1 Se fixează **PL** cu **F** prin 4 x **C5** (confirmatoare)
- 2 Se fixează **T** cu **PL** prin 2 x 2 x **K**
- 3 Se fixează **G** (glisierile) cu **S3** de **PL** stanga și dreapta
- 4 Se fixează **T** (talpi) cu 2 x **S3** de **F** (fund)
- 5 Se aduce corpul la unghi de 90 și se fixează HDF cu **Q** (cuie)
- 6 Se strâng **K** și se poziționează sertarul pe glisieră

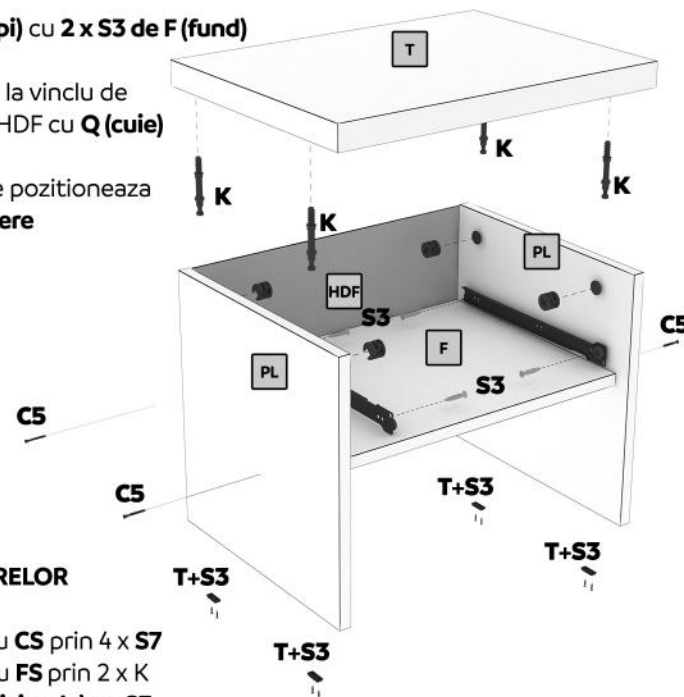

MONTAJUL SERTARELOR

- 1 Se fixează **LS** cu **CS** prin 4 x **S7**
- 2 Se fixează **LS** cu **FS** prin 2 x **K**
- 3 Se fixează **G** (glisierile) cu **S3**
- 4 Se fixează **M** (maner patrat) cu 2 x **M2**
- 5 Se aduce sertarul la unghi de 90 și se fixează fundul de sertar cu **Q** (cuie)

