

# DULAP 4 usi MELODY



## ATENȚIE!

Montajul necorespunzător atrage după sine pierderea garanției produsului.



facebook.com/MobilaLaguna



www.mobilalaguna.ro



Acordați o atenție sporită!  
Posibilitate de accidentare!



Reciclează obiectele vechi de mobilier și ambalajul produselor LAGUNA. Protejează natura!



**LAGUNA**<sup>®</sup>  
mobilă pentru acasă

CONFIRMATOR 50mm

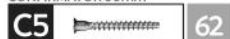

62

ORNAMENT USA



4

SURUB - 3.5 X 16 mm

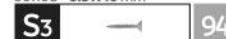

94

PROFIL "H" - imbinare HDF



2m

SURUB AUTOFORANT 3 X 20 mm



16

CUIE



120

SET GLISIERE



1

KIT DEMONTABIL (tija + camă)



14

SURUB - 3.5 X 40 mm

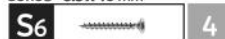

4

MANER MELODY



5

SUPORT POLITA MOBILA



24

BARA HAINE + SUPORTI BARA



1

TALPA / protecție podea

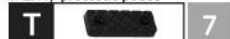

7

AUTOCOLANTE BULINE



6

BALAMA APLICATA



8

SURUB M4 x 22 mm

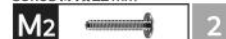

2

SURUB M4 x 30 mm

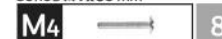

8

BALAMA SEMIAPLICATA



8

SAIBA TIP CUPA



28

## REPERE

SIMBOL BUCATI

DENUMIRE

TV	1	<b>TAVAN</b> DIMENSIUNI REPER: 1770 X 550
FU	1	<b>FUND</b> DIMENSIUNI REPER: 1736 X 550
PL	2	<b>PERETE LATERAL</b> DIMENSIUNI REPER: 2117 X 550
PI	2	<b>PERETI INTERMEDIARI</b> DIMENSIUNI REPER: 2032 X 550
FS	1	<b>FATA/FRONT SERTAR</b> DIMENSIUNI REPER: 880 X 299
LS	2	<b>LATERALA SERTAR</b> DIMENSIUNI REPER: 450 X 120
CS	1	<b>CAPAT SERTAR</b> DIMENSIUNI REPER: 810 X 120
FHS	1	<b>FUND HDF SERTAR</b> HDF
HDF	1	<b>HDF SPATE</b> HDF
PFM	2	<b>POLITE FIXE MARI</b> DIMENSIUNI REPER: 868 X 550
PF	4	<b>POLITE FIXE</b> DIMENSIUNI REPER: 418 X 550
PM	4	<b>POLITA MOBILA</b> DIMENSIUNI REPER: 418 X 500
PR	1	<b>PROFIL</b> DIMENSIUNI REPER: 880 X 30 X 25
CD	1	<b>COROANA DULAP</b> DIMENSIUNI REPER: L
Um	2	<b>USA MICA</b> DIMENSIUNI REPER: 1741 X 438
UM	2	<b>USA MARE</b> DIMENSIUNI REPER: 2060 X 438
SM	2	<b>SOCLURI MARI</b> DIMENSIUNI REPER: 1763 X 69
Sm	1	<b>SOCLU MIC</b> DIMENSIUNI REPER: 516 X 69

## MONTAJUL SERTARULUI

- 1 Se fixează **LS** cu **CS** prin 4 x **S7**
- 2 Se fixează **LS** cu **FS** prin 2 x **K**
- 3 Se fixează **G** (glisierele) cu **S3**
- 4 Se fixează **MM** (maner) cu 2 x **M2**
- 5 Se aduce sertarul la unghi de 90° și se fixează fundul de sertar cu **Q** (cuie)

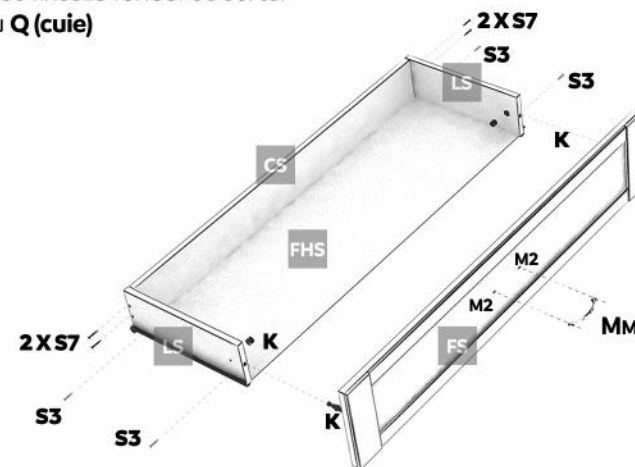

- 1 Se prind peretii intermediari **PI** intre ei prin **PFM**, utilizand cate **3 x C5** (confirmator) pe fiecare polita.
- 2 Se fixeaza ansamblul construit la **punctul 1** de peretii laterali **PL** prin **PF**, prinse in **3 x K** pe **PL** si **3 x C5** pe **PI**.
- 3 Se aseaza politele mobile utilizand **6 x P** / fiecare polita **PM**. **Se fixeaza glisierele (G) cu S3.**
- 4 Se monteaza **tavanul (TV)** prin cate **3 x C5 (confirmatoare)** in peretii laterali si intermediari - **PL** si **PI**.
- 5 Se fixeaza barele pt haine cu suruburi **S3** in **PI stang si PI drept.**
- 6 Se fixeaza fundul in **3 x C5 in PL** si **3 x C5 in PI.**
- 7 Se fixeaza SM si Sm **cu confirmatoare C5** in FU
- 8 Se monteaza profilul **PR** de **PFM** cu **AF**

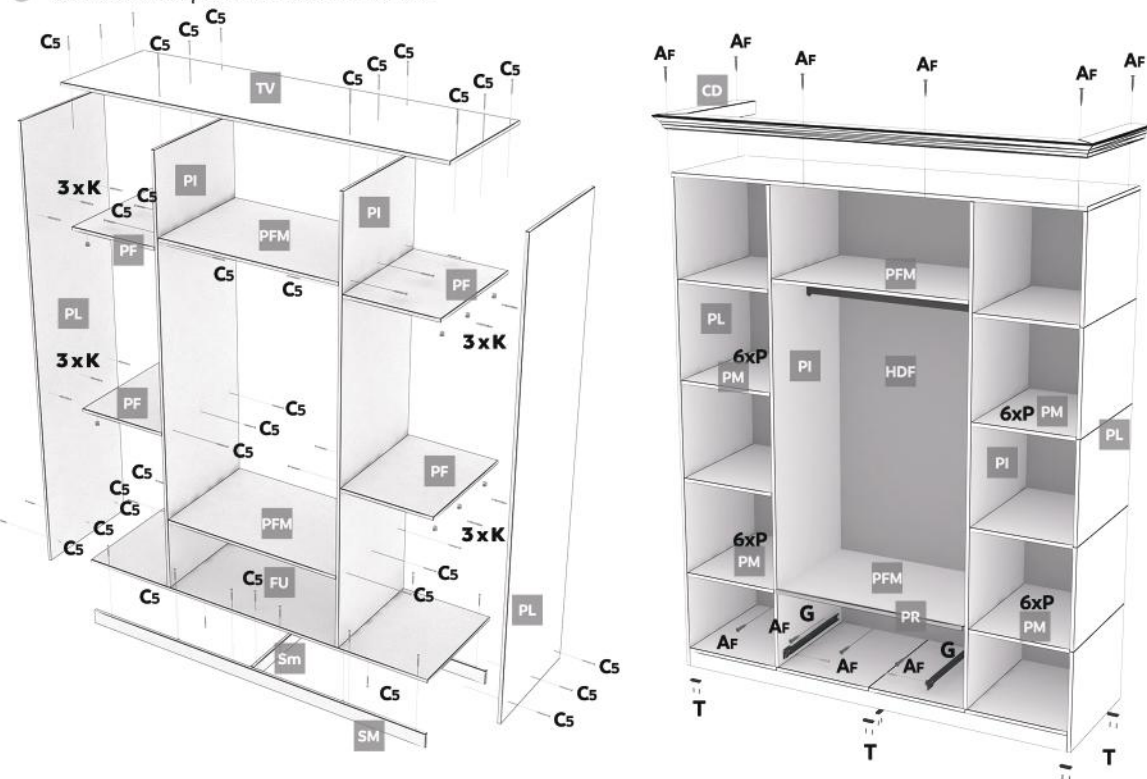

- 9 Se aduce corpul la vinclu de 90 si se prinde HDF de spatele dulapului cu Q, R si cu PH.

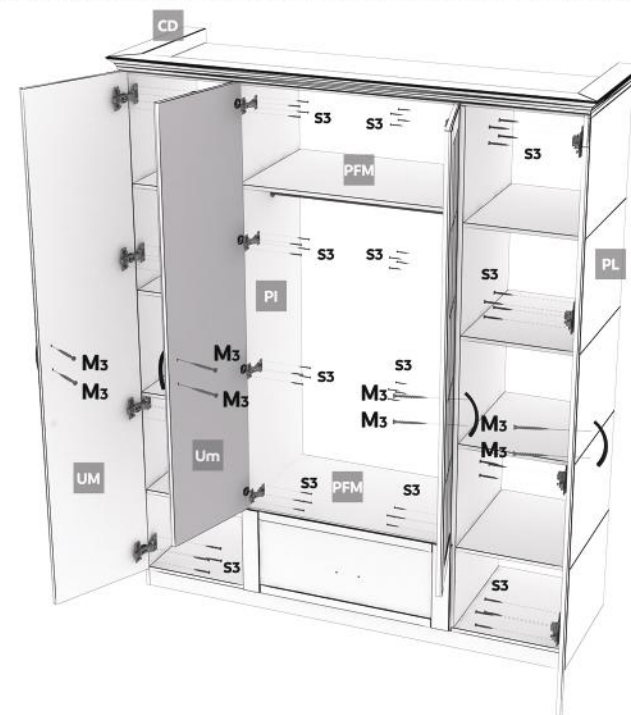

- 1 Se fixeaza coroana CD de tavan prin **AF**.
- 2 Se monteaza usile mari (**2 x UM**) cu 4 x Ba si 16 x S3 / usa
- 3 Se monteaza usile mici (**4 x Um**) cu 4 x Bs si 16 x S3 / usa
- 4 Se monteaza manerele usilor: Pentru **UM, Um**: suruburi **M3**
- 5 Se monteaza T (talpi alunecatoare plastic) 7 buc cu **2 x S3**

